

Article number: 204280M24200A1U

Description: E+G levelling foot
GN 42-80-M24-200-A1-U

Note: U Without nut, Hexagon socket at the top, Wrench flat at the bottom

Measures

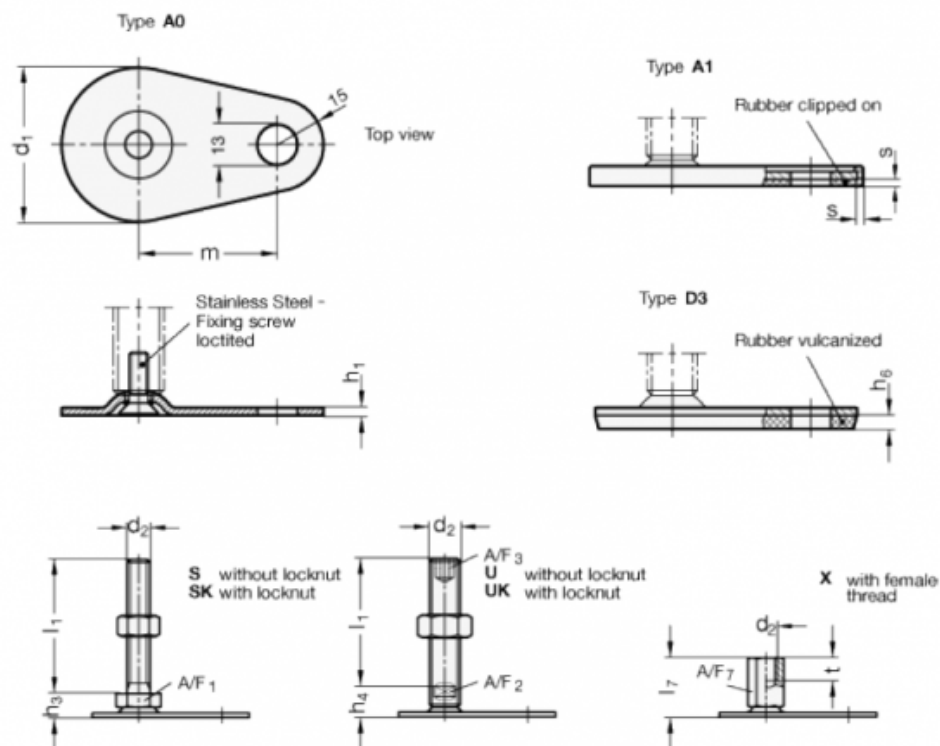

A/F2 = 19	m = 70
A/F3 = 12	s = 2
d1 = 80	
d2 = M24	
h1 = 3	
h4 = 21	
h6 =	
l1 = 200	